

MINUS TWO - RETROFIT | LOW VOLTAGE INSTALLATION INSTRUCTIONS

Please read these instructions in their entirety prior to the start of the installation to ensure a proper and functional installation. Carefully review each step and confirm you have the necessary tools and compatible drivers to complete every step.

WARNING & SAFETY INSTRUCTIONS

- DO NOT INSTALL DAMAGED PRODUCT! Upon receipt, thoroughly inspect for any freight damage which should be brought to the attention of the delivery carrier.
- Compare the catalog description listed on the packing slip with the label on the carton to ensure you have received the correct merchandise.
- Read and familiarize yourself with the nomenclature and instructions before starting installation.
- RISK OF ELECTRIC SHOCK! Turn off electricity at the breaker panel or fuse box and follow NEC and all local electrical building codes and practices.
- RISK OF INJURY! Avoid direct eye exposure to the light source while it is on.
- Do not install directly to line voltage! Remote power supply is required. Follow all instructions by the manufacturer!
- Do not power on fixture with lens protector installed.
- Avoid direct contact with light source. The fixture lens must have a minimum clearance of 1 foot (30cm) at all times.
- Do not submerge this product under water.
- Do not install incompatible dimmers with driver. Check dimmer compatibility on the driver cutsheet.

THESE INSTRUCTIONS DO NOT PURPORT TO COVER ALL DETAILS OR VARIATIONS IN EQUIPMENT NOR TO PROVIDE FOR EVERY POSSIBLE CONTINGENCY TO BE MET IN CONNECTION WITH INSTALLATION, OPERATION OR MAINTENANCE. SHOULD FURTHER INFORMATION BE DESIRED OR SHOULD PARTICULAR PROBLEMS ARISE WHICH ARE NOT COVERED SUFFICIENTLY FOR THE CUSTOMER/OPERATOR'S PURPOSES THE MATTER SHOULD BE REFERRED TO APURE DISTRIBUTION, LLC.

Failure to follow any of these instructions could void product warranties. For a complete listing of product Terms and Conditions, please visit www.apurelighting.com. Apure assumes no responsibility for claims arising out of improper or careless installation or handling of its products.

Resources / Installation Videos

Scan QR Code or visit at apurelighting.com/resources/



Resources



Videos



MINUS TWO - Retrofit

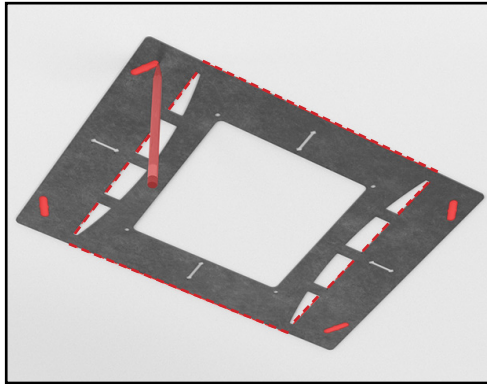

1. Ensure that any existing framing or studs do not interfere with the intended fixture location. Using the bracket as a template, mark the drill and cut lines with a pencil. The bracket has center lines to help with the alignment of the fixture.

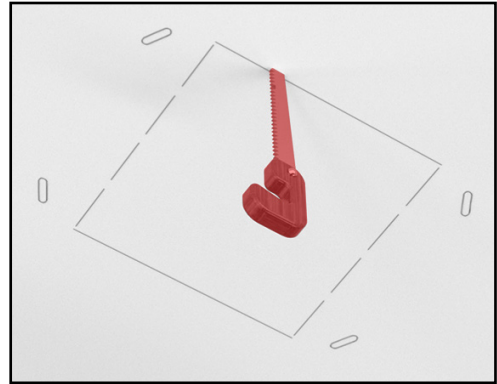

2. Place the drywall bracket to the side and cut out the marked square using a jab saw.

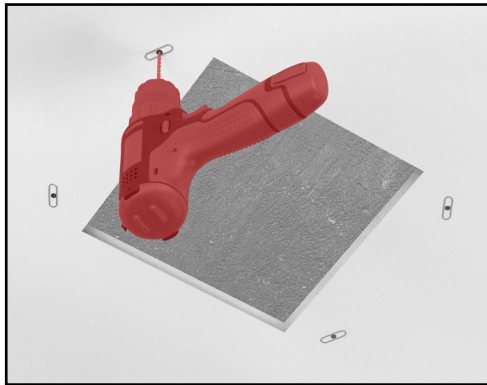

3. Drill four, quarter inch (6.35mm) holes in the center of the slotted markings. The holes must be centered to allow for fine tuning of the fixture bracket once installed.

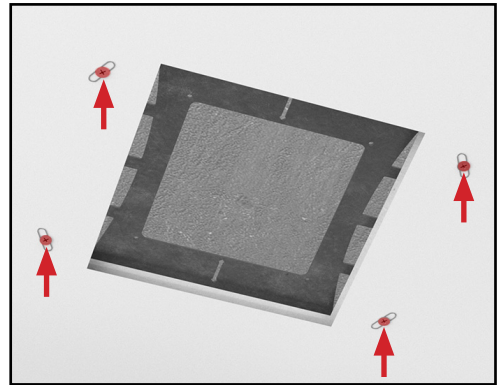

4. Take the drywall bracket and insert it into the ceiling opening. Insert the screws included with the universal drywall bracket through the drilled holes.

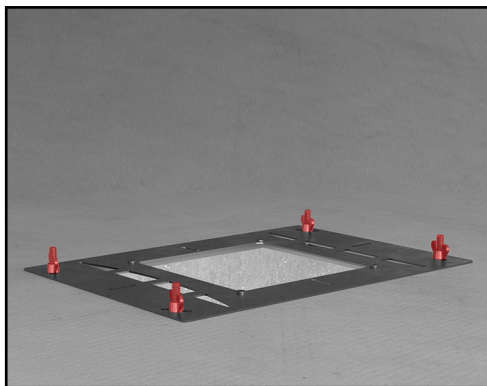

5. Fasten the bracket to the ceiling by tightening the wing nuts.

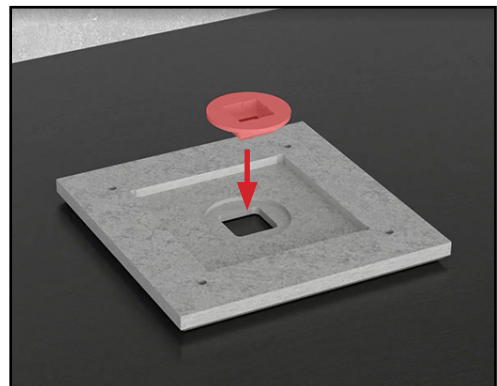

6. Insert the guard into the fiber board.

MINUS TWO - Retrofit. Cont'd

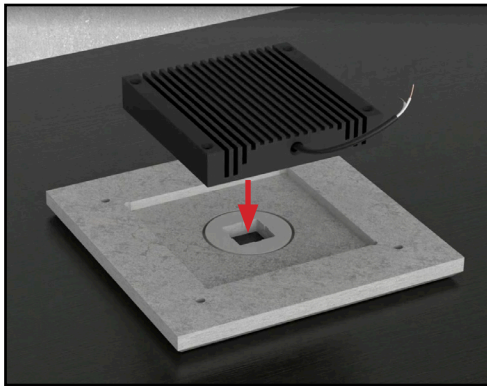

7. Take the Minus fixture and place it onto the mounting board.

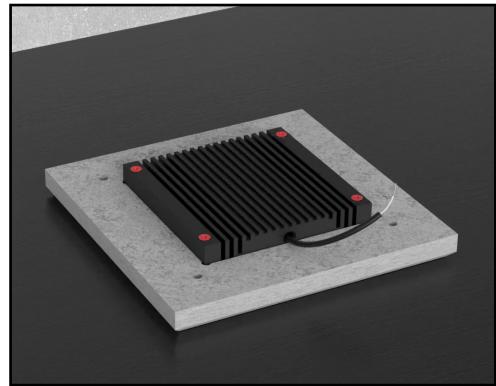

8. Secure the Minus fixture to the board by fastening the screws provided with the fixture to complete the fixture board assembly.

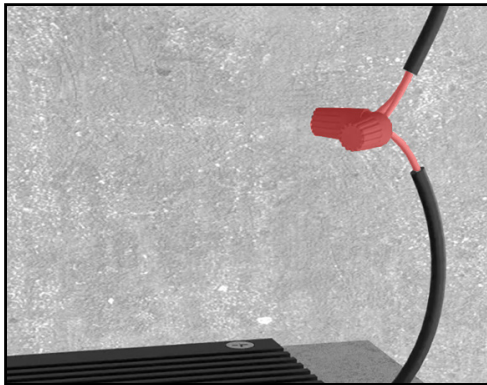

9. Feed **low voltage** wiring to the bracket and lift the fixture board assembly to the **low voltage** electrical connection and make the connection.

Note: Please refer to wiring diagram on page 6.

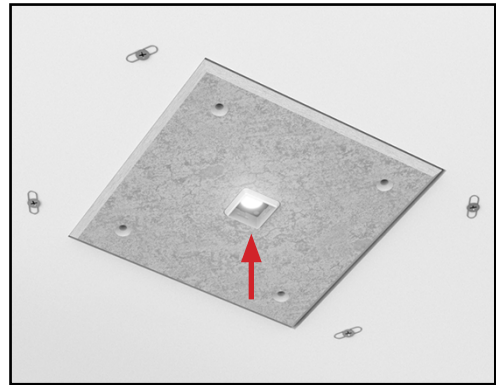

10. Insert the fixture board assembly into the cutout. Test the fixture is fully operational. Do not move on to the next step until the fixture is operational.

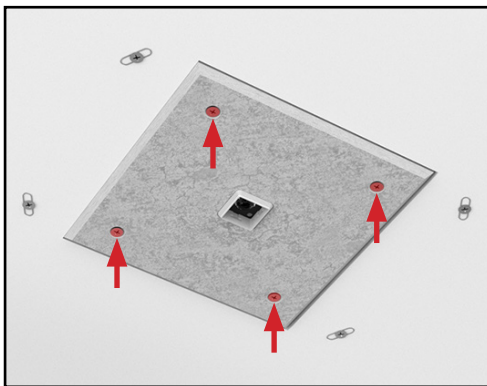

11. Secure the board to the drywall bracket using the provided screws.

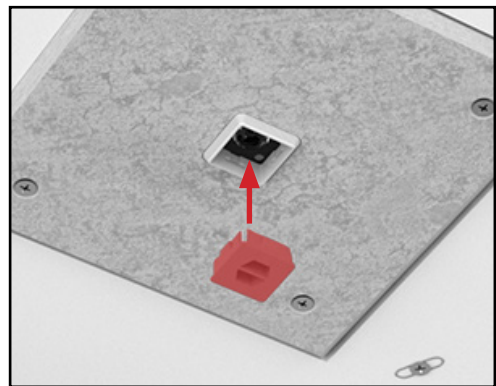

12. Insert the finishing guard into the fixture opening to prepare for finishing. The fixture must remain off for the remainder of the installation.

MINUS TWO - Retrofit, Cont'd.

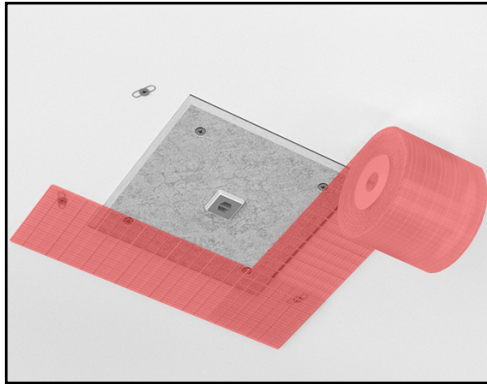

13. Tape the seams between the drywall board and ceiling. Joint compound may be used to fill any gaps before applying the tape.

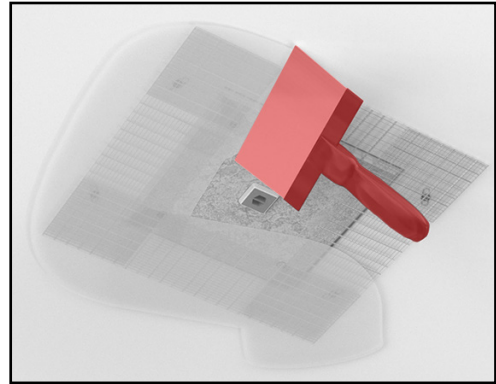

14. Allow for the tape to dry and apply your first coat of plaster to the tape seam, lightly skim coating the surface of the fixture board assembly.

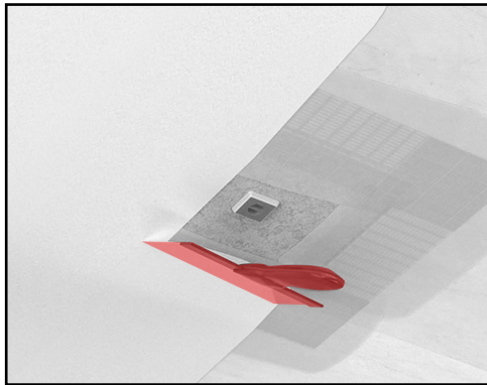

15. Apply the subsequent coat of plaster to level out the board with the existing drywall finish.

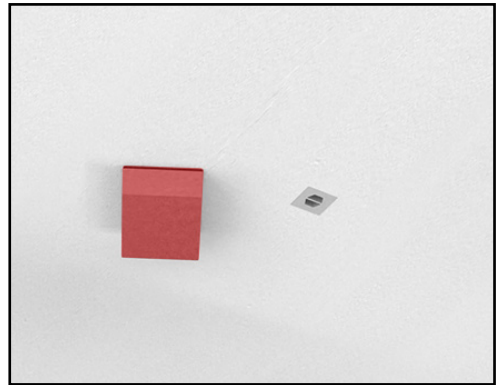

16. Wait until the surface has fully dried, and sand the plastered ceiling to match the surrounding level of drywall.

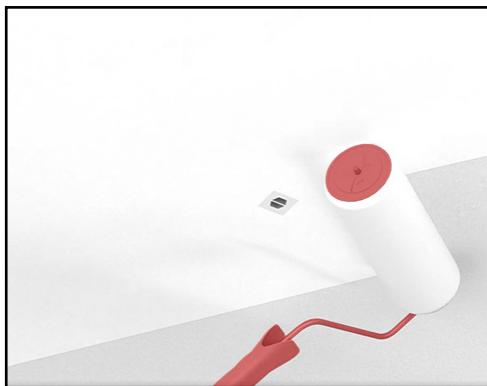

17. Paint the surface.

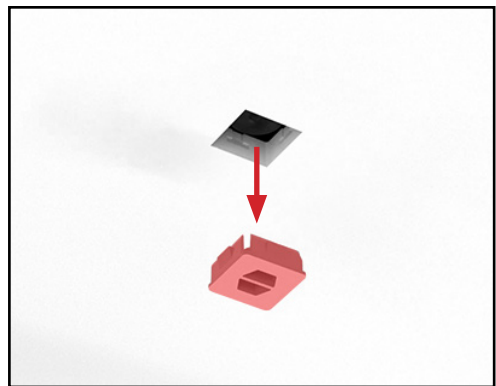

18. Carefully remove the finishing guard from the fixture opening.

MINUS TWO - Retrofit, Cont'd.

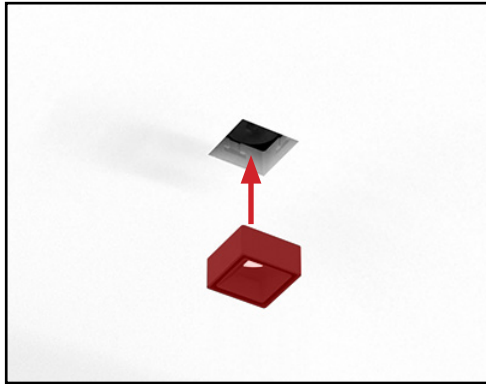

19. Insert the louver into the fixture opening to magnetically attach the louver.

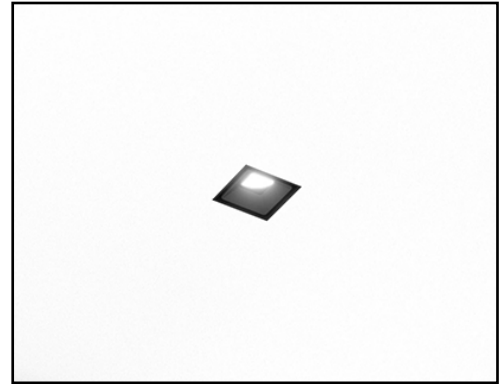

20. The installation is now complete.

Wiring diagram on the following page.

Wiring Diagram for 12V Minus Products - [EU]

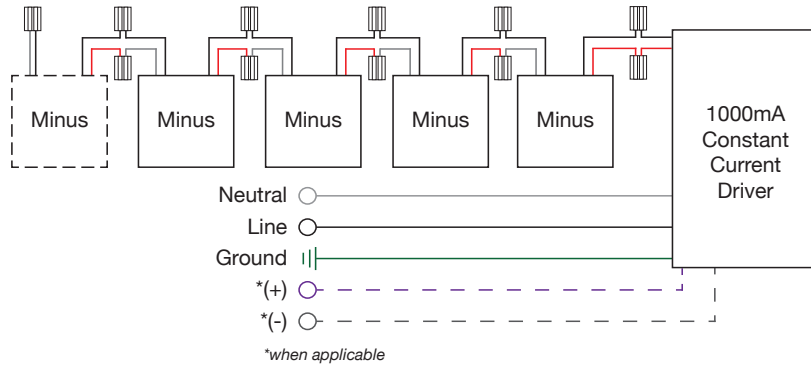

Fixture Leads In
Red with Red (+)
Black with Black (-)

Fixture Leads Out
Black with Black
White with Red

Warning: failure to wire correctly may cause fixture to fail.

Note: The white and black cables of the last fixture in the series must be bridged together!

Additional Considerations

The above wiring diagram applies only to 12V Minus products with product ordering codes ending with "EU". The diagram above shows the typical wiring schematic, however the total number of fixtures per driver is driver specific.

- Magnitude AFLEX Power Supply (1000mA 60W) 1-4 Minus 16AWG - 82ft (25m)
- Apure Phase Dimmable (1000mA 29W) 1-2 Minus 16AWG - 82ft (25m)
- Apure Phase Dimmable (1000mA 30-65W) 3-5 Minus 16AWG - 82ft (25m)
- Apure DALI, Push, 1-10V (1000mA 30-65W) 1-4 Minus 16AWG - 82ft (25m)

WARNING: The power supply must operate within the range of minimum to maximum fixtures. Operation with less or more fixtures from the specified amount will result in damage to the power supply and/or lighting fixture. Incorrectly wiring the 12V EU lighting fixture may cause luminaire to fail.

Wiring Diagram for 24V Minus Products - [A] MLV or [L] Lutron

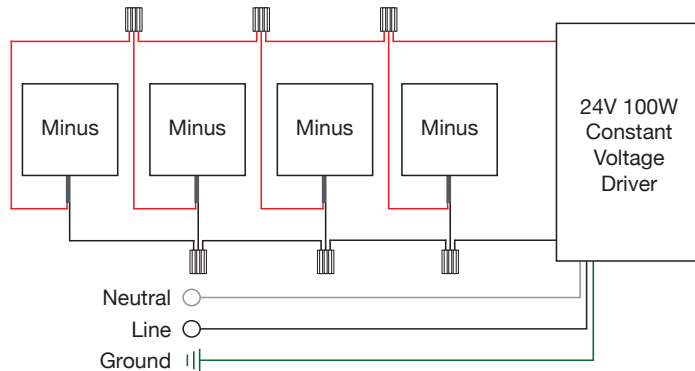

Fixture Leads
Red (+)
Black (-)

Additional Considerations

The above wiring diagram applies only to 24V Minus products with product ordering codes ending with "A" or "L". The diagram above shows the typical wiring schematic, however the total number of fixtures per driver is driver specific.

- Magnitude Constant Voltage Driver (96W 24VDC) 1-4 Minus ≤16AWG - 150ft (45m)
- Lutron Hi-Lume Constant Voltage Driver (96W 24VDC) 1-4 Minus ≤16AWG - 150ft (45m)
- Lutron HomeWorks Constant Voltage Driver (96W 24VDC) 1-4 Minus ≤16AWG - 150ft (45m)

WARNING: The power supply must operate within the range of minimum to maximum fixtures. Operation with less or more fixtures from the specified amount will result in damage to the power supply and/or lighting fixture.